

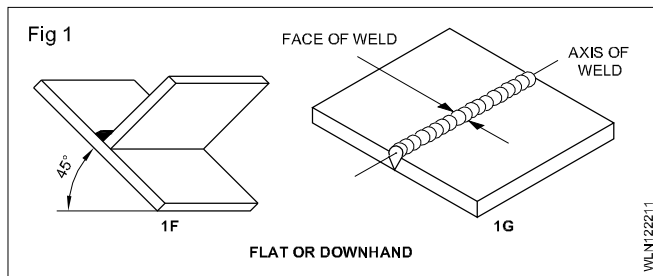
**Basic welding positions**

**Objective :** At the end of this lesson you shall be able to

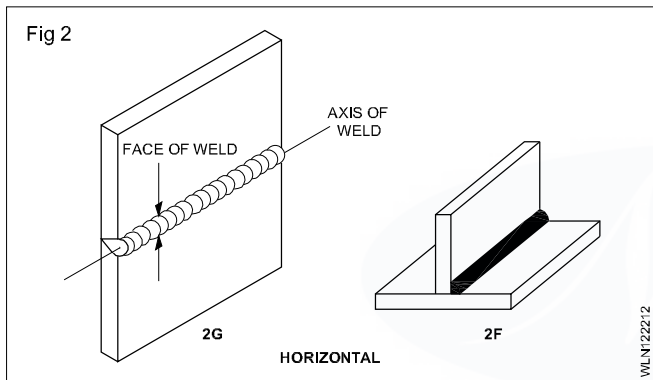
- name and illustrate the basic welding positions.

**Basic welding positions**

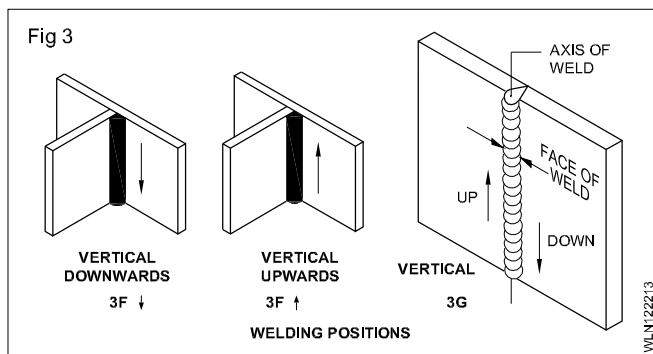
- Flat or down hand position (Fig 1)



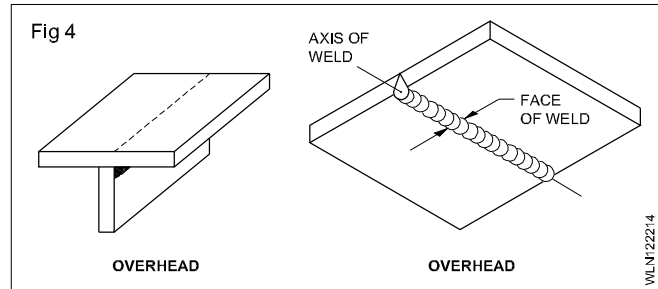
- Horizontal position (Fig 2)



- Vertical position (Vertical up and down) (Fig 3)



- Overhead position (Fig 4)



All welding action takes place in the molten pool, formed in the welding joint/welding line.

The position of the welding joint line and the weld face in respect of ground axis indicates the welding position.

All joints may be welded in all positions.

**Plate welding position:**

Welding position	EN		ASME	
	Groove	Fillet	Groove	fillet
Flat	PA	PA	1G	1F
Horizontal	PC	PB	2G	2F
Vertical	PG/PF	PG/PF	3G	3F
Overhead	PE	PD	4G	4F

**Pipe welding position:**

Welding position	EN	ASME
	Groove	Groove
Flat	PA	1G
Horizontal	PC	2G
Multiple position	PF/PG	5G
Inclined (All position)	H-LO45	6G

**Weld slope and rotation**

**Objectives :** At the end of this lesson you shall be able to

- define and explain weld slope and weld rotation with respect to butt and fillet joint
- illustrate the various weld positions with respect to slope and rotation as per I.S.

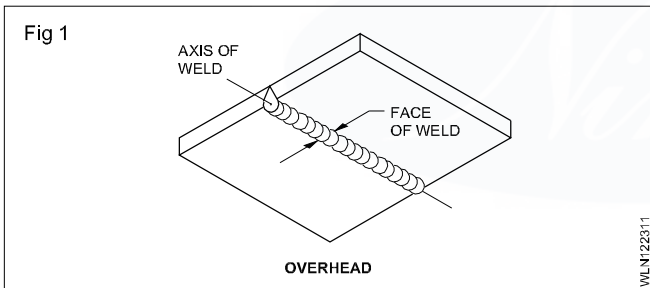
**Welding position:** All welding is to be done in one of the four positions mentioned below.

- 1 Flat or down hand
- 2 Horizontal
- 3 Vertical
- 4 Overhead

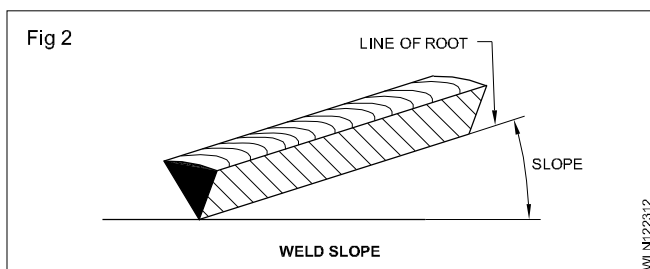
Each of these positions can be decided by the angle formed by the axis of the weld and the weld face with the horizontal and vertical plane respectively.

**Axis of weld:** The imaginary line passing through the weld center lengthwise is known as axis of the weld. (Fig 1)

**Face of weld:** Face of weld is the exposed surface of a weld made in a welding process on the side from which the welding is done. (Fig 1)



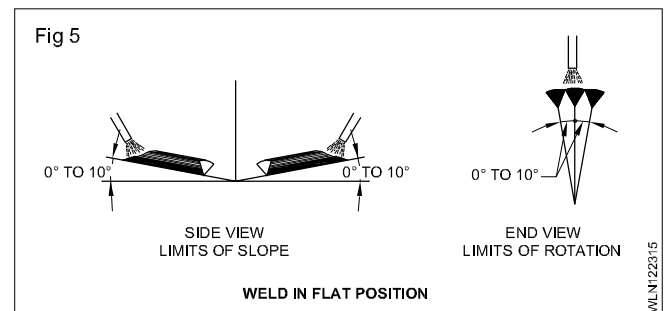
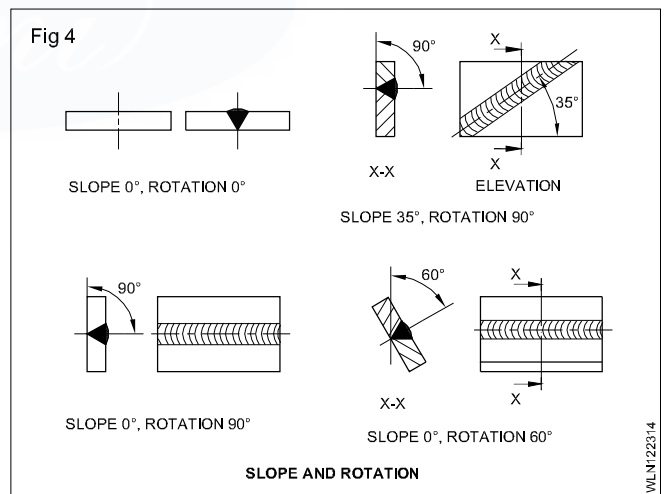
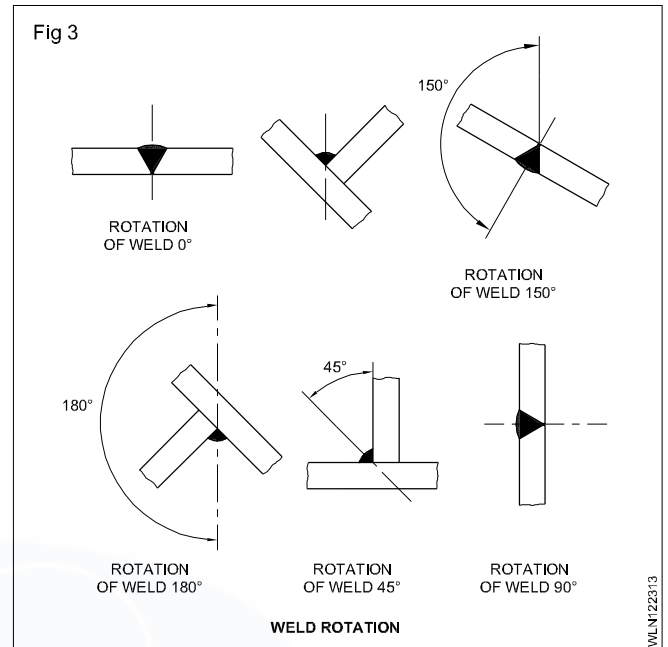
**Weld slope (Fig 2):** It is the angle formed between the upper portion of the vertical reference



**Weld rotation (Fig 3):** It is the angle formed between the upper portion of the vertical reference plane passing through the line of the weld root and that part of the plane passing through the weld root and a point on the face of the weld equidistant from both the edges of the weld.

Slope and rotation (Fig 4)

Weld in flat position. (Fig 5)

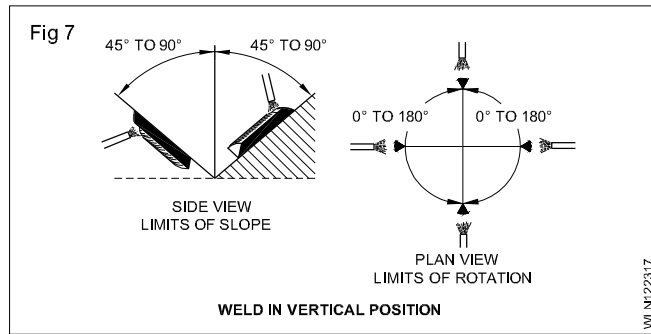
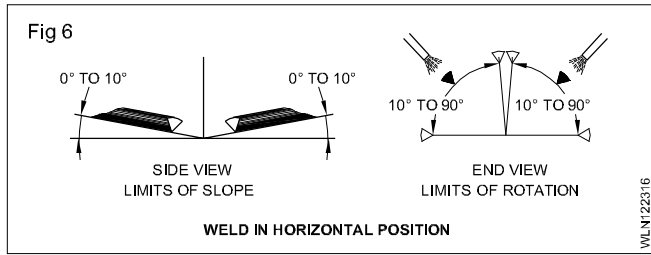


WLN122313

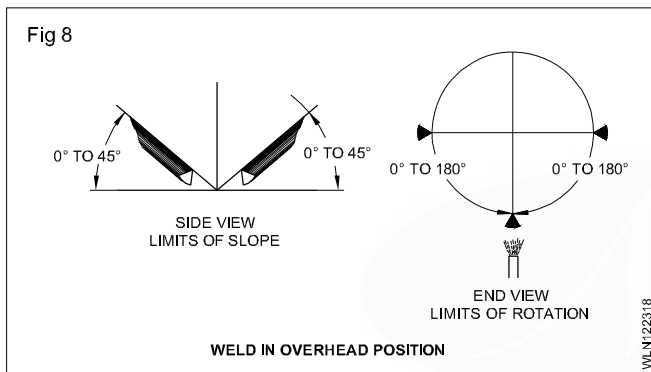
WLN122314

WLN122315

Weld in horizontal and vertical position. (Fig 6 & 7)



Weld in overhead position. (Fig 8)



Weld slope and weld rotation in respect of all the four positions are shown above.

Definitions of welding positions with respect to their slope and rotation angles a Table is given below.

**Definition of welding position**

Position	Symbol	Slope	Rotation
Flat or down hand	F	Not exceeding 10°	Not exceeding 10°
Horizontal	H	Not exceeding 10°	Exceeding 10° but not beyond 90°
Vertical	V	Exceeding 45°	Any.
Overhead	O	Not exceeding 45°.	Exceeding 90°.

**Weld symbol and welding symbol - Description and uses**

**Objectives :** At the end of this lesson you shall be able to

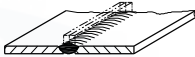

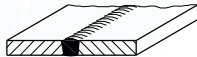







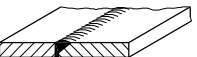

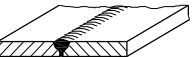

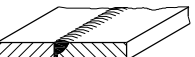



- explain the necessity of weld symbol and welding symbol
- describe the elementary symbols and supplementary symbols
- describe the welding symbol and its application, as per symbol standard (BIS) and AWS.

**Necessity:** For conveying the information required for welding for designers and welders, standard symbols are used. The symbols described below provide the means of placing on drawing the information concerning type, size, location of weldment.

**Elementary symbols** (As per IS 813 - 1986): The various categories of welds are characterized by a symbol which in general is similar to the shape of the weld to be made. (Table 1)

**Supplementary symbols:** Elementary symbols may be complemented by another set of symbols (supplementary) (Table 2) characterizing the shape of the external surface of the weld. Supplementary symbols on elementary symbols indicate the type of weld surface required. (Table 3)

**TABLE 1  
Elementary symbols**

Sl. No.	Designation	Illustration	Symbol
1	Butt weld between plates with raised edges (the raised edges being melted down completely)		
2	Square butt weld		
3	Single V butt weld		
4	Single bevel butt weld		
5	Single V butt weld with broad root face		
6	Single bevel butt weld with broad root face		
7	Single U butt weld (Parallel or sloping sides)		
8	Single J butt weld		
9	Backing run; back or backing weld		

Sl. No.	Designation	Illustration	Symbol
10	Fillet weld		
11	Plug weld; Plug or slot weld/USA		
12	Spot weld		
13	Seam weld		

**TABLE 2**  
**Supplementary symbols**

Shape of weld surface	Symbol
a) Flat (Usually finished flush)	
b) Convex	
c) Concave	

**Table 3**

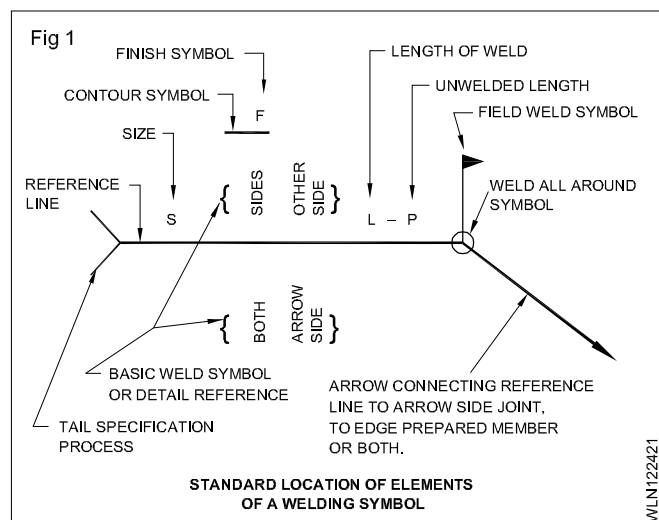
**Examples of application of supplementary symbols**

Designation	Illustration	Symbol
Flat (flush) single V		
Convex double V butt weld		
Concave fillet weld		
Flat (flush) single V butt weld with flat (flush) backing run		

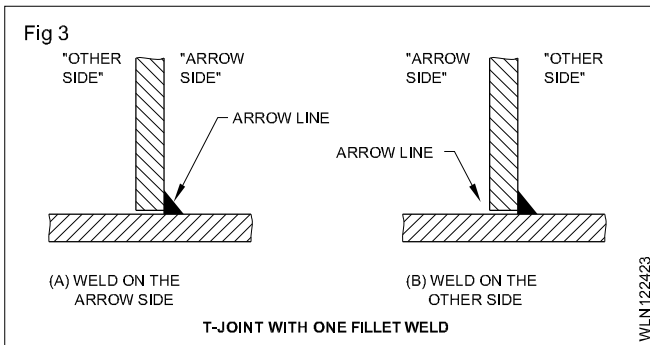
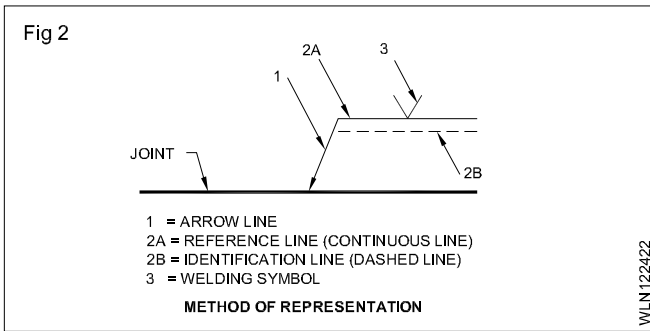
**Weld symbol:** It represents the type of weld made on a weld joint. It is also a miniature drawing of any metal edge preparation required prior to welding,

**Welding symbol:** The complete welding symbol will indicate to the welder how to prepare the base metal, the welding process to use, the method of finish and the required dimensions and other details with the basic weld symbol. They consist of 7 elements as mentioned below. (Fig 1)

- 1 Reference line
- 2 Arrow
- 3 Welding elementary symbols
- 4 Dimensions and other details
- 5 Supplementary symbols
- 6 Finish symbols
- 7 Tail (Specification, process)



## Methods of representation (Fig 2 and 3)



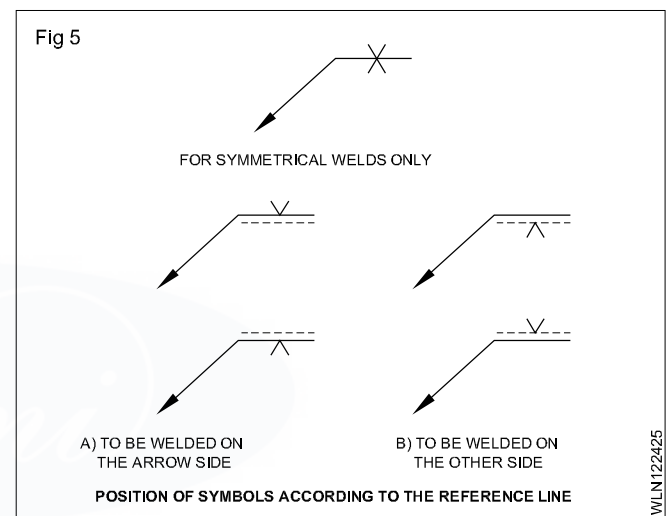
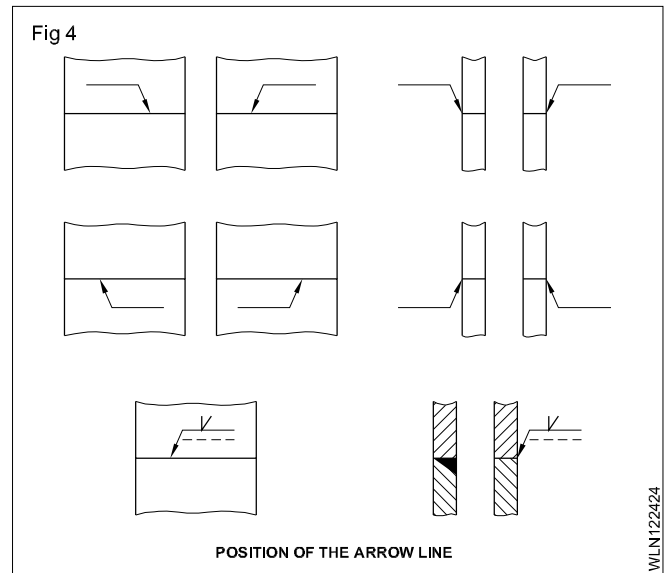
### The reference line, arrow-head and tail

The reference line shown in Figs 1 and 5 is always drawn as horizontal line. It is placed on the drawing near the joint to be welded. All other information to be given on the welding symbols is shown above below the reference line.

**Arrow:** The arrow may be drawn from either end of the reference line. The arrow always touches the line which represents the welded joint.

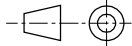

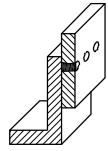
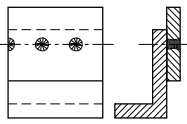
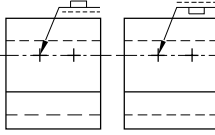
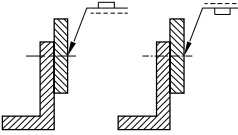
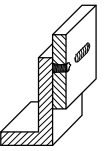
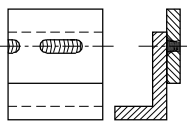
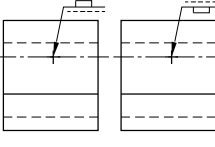
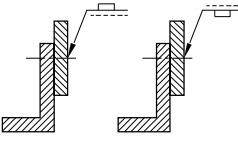

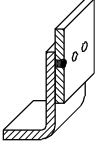
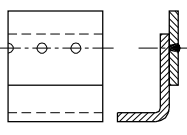
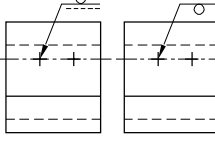
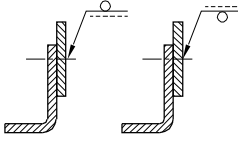
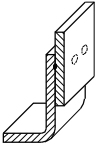
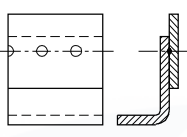
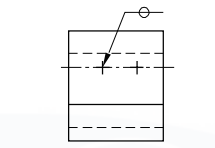
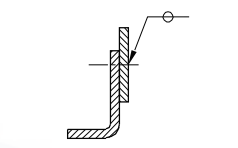
On the welding symbol the arrow side weld information is always shown below the reference line. The other side weld information is always shown on the dash- line side. (Figs 2 and 4)

**Tail:** The tail is used only when necessary. If used it may give information on specification, the welding process used. or other details required which are not shown in the welding symbol.



**Welding/elementary symbol:** Figs 6 and 7 illustrate how some of the various types of weld symbols are used in welding symbols.

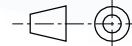

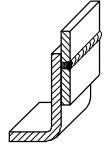
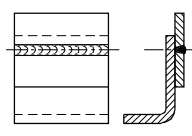
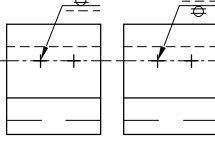
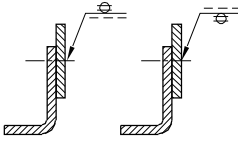
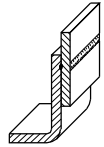
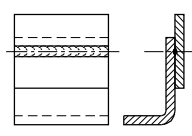
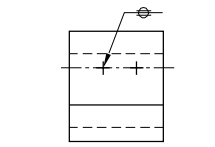
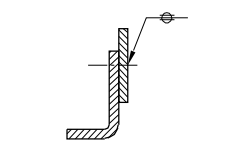
Fig 6

DESIGNATION SYMBOL (NUMBERS REFER TO TABLE 1)	ILLUSTRATION	REPRESENTATION 	SYMBOLIZATION	
			EITHER	OR
PLUG WELD  11				
				
SPOT WELD  12				
				

EXAMPLES OF USE OF ELEMENTRY SYMBILS

W/LN122426

Fig 7

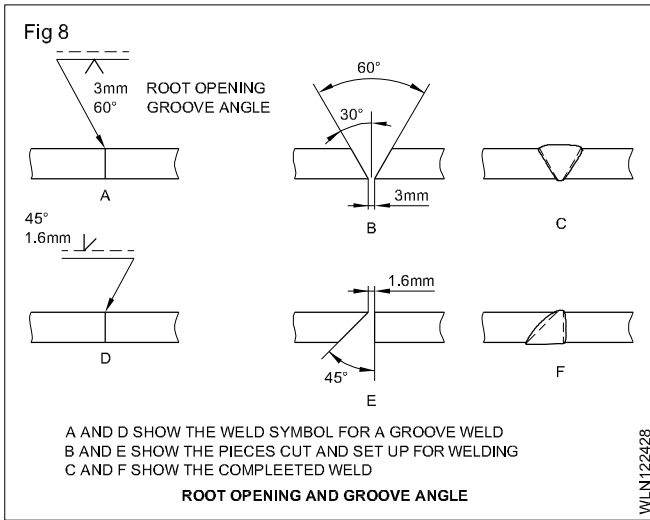
DESIGNATION SYMBOL (NUMBERS REFER TO TABLE 1)	ILLUSTRATION	REPRESENTATION 	SYMBOLIZATION	
			EITHER	OR
SEAM WELD  13				
				

EXAMPLES OF USE OF ELEMENTRY SYMBILS

W/LN122427

**Root opening and groove angle:** The root opening size appears inside the basic weld symbol on the complete welding symbol. The included angle or total angle of a groove weld is shown above the basic weld symbol. (Fig 8)

**Contour and finish symbols:** The shape or contour of the completed weld bead is shown on the welding symbol as a straight or curved line between the basic weld symbol and the finish symbol. The curved contour line indicates a normal convex or concave weld bead. (Fig 9)



**Dimensions and other details:** The size of a weld is important. The term 'size of weld' means different things for the fillet weld and butt weld. The dimensions of a fillet weld are shown to the left of the basic weld symbol. (Fig10) The number 300 indicates the length of the weld is 300mm; a5 indicates that the throat thickness is 5mm; Z7 indicates that the leg length is 7mm.

